

survitec

PREMIER

FOAM LIFEJACKET ↓



Since its introduction in July 2010, the Crewsaver Premier lifejacket has led the way in passenger and crew lifejacket safety. The first lifejacket to be approved to ISO 200(80), the Premier has since gone on to be the choice of both the largest Cruise ships and some of the most discerning superyachts and commercial vessels worldwide.

With a design brief that stipulated ease and intuitive donning, mirroring the hugely successful original Premier (over 750,000 units sold), the Premier uses a patented "Reverse Angle Head Support" to achieve the vital in-water performance that the regulations require.

The unique design of the neck opening allows for increased wearer comfort, while durability is assured by the use of tried and tested quality components.

FEATURES

- MED APPROVED LIGHTS
- OPTIONAL SPRAY HOOD
- DONNING INSTRUCTIONS
- AVAILABLE IN ADULT, CHILD AND INFANT SIZES
- HIGHLY VISIBLE COLOUR WITH SOLAS APPROVED RETRO REFLECTIVE TAPE
- BUDDY LINE AND WHISTLE STORED IN RECESSED POCKET
- WAIST BELT DESIGNED TO FIT CHEST GIRTH OF 1750MM
- SACRIFICIAL STITCH AT THE END OF THE WAIST BELT TO ALLOW IT TO RUN FREE IF CAUGHT, HELPING TO PREVENT SNAG HAZARDS
- YELLOW CREW OPTION AVAILABLE



The Premier uses a patented "reverse angle head support" to achieve the vital in-water performance.

PREMIER

FOAM LIFEJACKET

ADULT



TECHNICAL DATA	
Adult/ Adult Crew	>43 kg 181N
Child	15 kg to 43 kg 106N
Infant	Up to 15 kg 68N
Type	Lifejacket
Flotation	Foam

OPTIONS AVAILABLE

CREW



CHILD



INFANT



The Premier is also available in an identical 'Crew' design, manufactured in a distinctive yellow colour scheme specifically for the ship's crew, allowing passengers to easily identify them in the event of an emergency.

PREMIER

FOAM LIFEJACKET

DIMENSIONS (BASED ON ADULT SIZE)

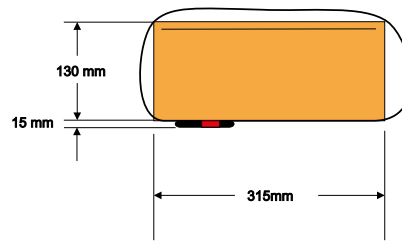
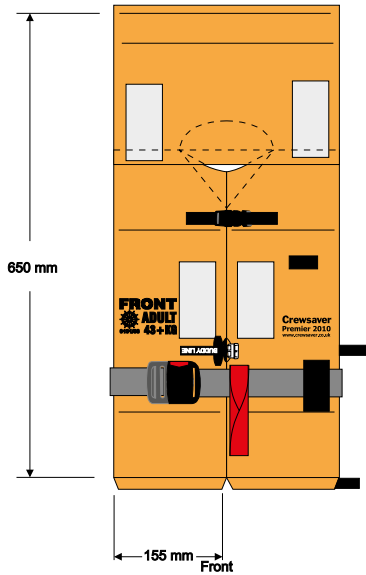

STORED JACKETS

Flat

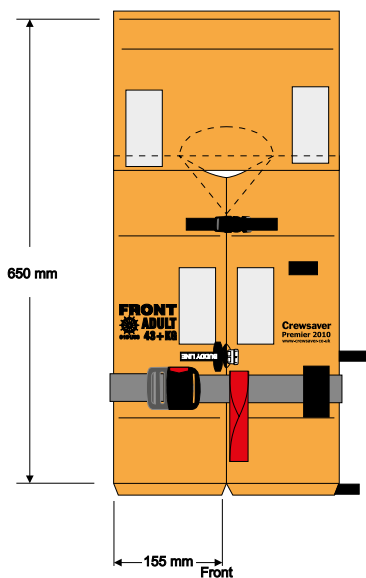
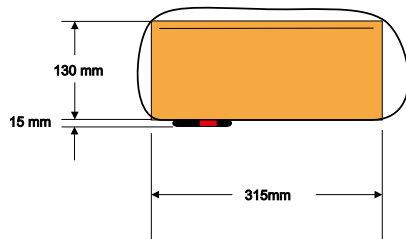

Folded

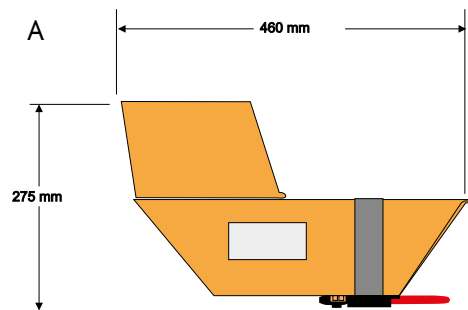

Stacked

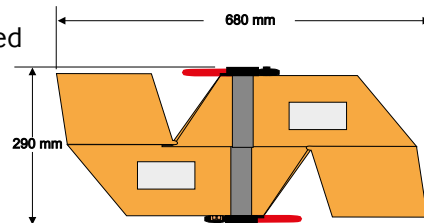

C

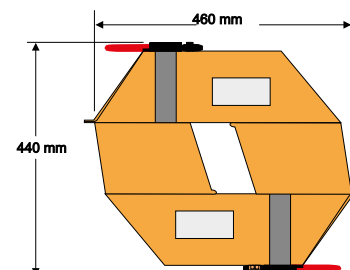



Accessories

PRODUCTS	
Product Number	Product Name
10282	Universal Light SOLAS and Recessed Adaptors
10281	Universal Light SOLAS and Surface Mount Bracket
10659	Premier Spray Hood
10032	Crotch Straps
10278	Universal Light SOLAS with Integrated Sensor and Surface Mount Bracket
10276	Universal Light SOLAS with Integrated Sensor and Recessed Adaptors
10277	Crewsaver Alkaline Light (CAL)
11270	Crewsaver Alkaline Light (CAL) with Surface Mount Clip
11271	Surface Mount Clip for CAL
11272	Circular Recessed Housing for CAL
11273	Rectangular Recessed Housing for Crewsaver Universal Light and CSL

Ordering Information

PRODUCTS	
Product Number	Product Name
10572	Premier Lifejacket no Light Adult Orange
10573	Premier Lifejacket no Light Child Orange
10574	Premier Lifejacket no Light Infant Orange
10575	Premier Crew Lifejacket no Light Adult Yellow
12610	Premier Lifejacket Adult and Universal Surface Light With Integrated Sensor
12616	Premier Lifejacket Child and Universal Surface Light with Integrated Sensor
12617	Premier Lifejacket Infant and Universal Surface Light with Integrated Sensor
12618	Premier Lifejacket Crew and Universal Surface Light with Integrated Sensor
12611	Premier Lifejacket Adult and Universal Recessed Light With Integrated Sensor
12612	Premier Lifejacket Crew and Universal Recessed Light with Integrated Sensor
12668	Premier Lifejacket Child and Universal Recessed Light with Integrated Sensor
12669	Premier Lifejacket Infant and Universal Recessed Light with Integrated Sensor
13610	Premier Lifejacket with CAL Surface Mounted Light Adult Orange
13616	Premier Lifejacket with CAL Surface Mounted Light Child Orange
13617	Premier Lifejacket with CAL Surface Mounted Light Infant Orange
13611	Premier Lifejacket with CAL Recessed Light Adult Orange
13668	Premier Lifejacket with CAL Recessed Light Child Orange
13669	Premier Lifejacket with CAL Recessed Light Infant Orange
13612	Premier Crew Lifejacket with CAL Recessed Light Adult Yellow
13618	Premier Crew Lifejacket with CAL Surface Mounted Light Adult Yellow

APPROVALS

MED/SOLAS

